

User Manual

Tektronix

CFG280
11 MHz Function Generator
070-8559-03



Copyright © Tektronix, Inc. 1991. All rights reserved.

Tektronix products are covered by U.S. and foreign patents, issued and pending. Information in this publication supercedes that in all previously published material. Specifications and price change privileges reserved.

Tektronix, Inc., P.O. Box 1000, Wilsonville, OR 97070-1000

TEKTRONIX and TEK are registered trademarks of Tektronix, Inc.

WARRANTY

Tektronix warrants that this product will be free from defects in materials and workmanship for a period of one (1) year from the date of shipment. If any such product proves defective during this warranty period, Tektronix, at its option, either will repair the defective product without charge for parts and labor, or will provide a replacement in exchange for the defective product.

In order to obtain service under this warranty, Customer must notify Tektronix of the defect before the expiration of the warranty period and make suitable arrangements for the performance of service. Customer shall be responsible for packaging and shipping the defective product to the service center designated by Tektronix, with shipping charges prepaid. Tektronix shall pay for the return of the product to Customer if the shipment is to a location within the country in which the Tektronix service center is located. Customer shall be responsible for paying all shipping charges, duties, taxes, and any other charges for products returned to any other locations.

This warranty shall not apply to any defect, failure or damage caused by improper use or improper or inadequate maintenance and care. Tektronix shall not be obligated to furnish service under this warranty a) to repair damage resulting from attempts by personnel other than Tektronix representatives to install, repair or service the product; b) to repair damage resulting from improper use or connection to incompatible equipment; or c) to service a product that has been modified or integrated with other products when the effect of such modification or integration increases the time or difficulty of servicing the product.

THIS WARRANTY IS GIVEN BY TEKTRONIX WITH RESPECT TO THIS PRODUCT IN LIEU OF ANY OTHER WARRANTIES, EXPRESSED OR IMPLIED. TEKTRONIX AND ITS VENDORS DISCLAIM ANY IMPLIED WARRANTIES OF MERCHANTABILITY OR FITNESS FOR A PARTICULAR PURPOSE. TEKTRONIX' RESPONSIBILITY TO REPAIR OR REPLACE DEFECTIVE PRODUCTS IS THE SOLE AND EXCLUSIVE REMEDY PROVIDED TO THE CUSTOMER FOR BREACH OF THIS WARRANTY. TEKTRONIX AND ITS VENDORS WILL NOT BE LIABLE FOR ANY INDIRECT, SPECIAL, INCIDENTAL, OR CONSEQUENTIAL DAMAGES IRRESPECTIVE OF WHETHER TEKTRONIX OR THE VENDOR HAS ADVANCE NOTICE OF THE POSSIBILITY OF SUCH DAMAGES.



Table of Contents

General Safety Summary	iii
Getting Started	1
Preparing the Function Generator for Use	2
Front Panel	4
Rear Panel	8
Reference	9
TTL Signals	9
Internal Sweep	10
External Sweep	11
Amplitude Modulation	12
Tone-Burst Generation and Stepped Frequency Multiplication	13
Appendix A: Specifications	17
Appendix B: Maintenance	23
Cleaning	23
Preparing for Shipment	23
Troubleshooting	24
Appendix C: Replaceable Parts	29
Standard Accessories	29
Optional Accessories	29

Table of Contents



General Safety Summary

Review the following safety precautions to avoid injury and prevent damage to this product or any products connected to it.

Injury Precautions

Use Proper Power Cord

To avoid fire hazard, use only the power cord specified for this product.

Avoid Electric Overload

To avoid electric shock or fire hazard, do not apply a voltage to a terminal that is outside the range specified for that terminal.

Ground the Product

This product is grounded through the grounding conductor of the power cord. To avoid electric shock, the grounding conductor must be connected to earth ground. Before making connections to the input or output terminals of the product, ensure that the product is properly grounded.

Do Not Operate Without Covers

To avoid electric shock or fire hazard, do not operate this product with covers or panels removed.

Use Proper Fuse

To avoid fire hazard, use only the fuse type and rating specified for this product.

General Safety Summary

Do Not Operate in Wet/Damp Conditions

To avoid electric shock, do not operate this product in wet or damp conditions.

Do Not Operate in Explosive Atmosphere

To avoid injury or fire hazard, do not operate this product in an explosive atmosphere.

Product Damage Precautions

Use Proper Voltage Setting

Before applying power, ensure that the line selector is in the proper position for the power source being used.

Provide Proper Ventilation

To prevent product overheating, provide proper ventilation.

Do Not Operate With Suspected Failures

If you suspect there is damage to this product, have it inspected by qualified service personnel.

Safety Terms and Symbols

Terms in This Manual

These terms may appear in this manual:



WARNING. Warning statements identify conditions or practices that could result in injury or loss of life.



CAUTION. Caution statements identify conditions or practices that could result in damage to this product or other property.

Terms on the Product

These terms may appear on the product:

DANGER indicates an injury hazard immediately accessible as you read the marking.

WARNING indicates an injury hazard not immediately accessible as you read the marking.

CAUTION indicates a hazard to property including the product.

Symbols on the Product

The following symbols may appear on the product:



DANGER
High Voltage



Protective Ground
(Earth) Terminal



ATTENTION
Refer to
Manual



Double
Insulated

Certifications and Compliances

CSA Certified Power Cords

CSA Certification includes the products and power cords appropriate for use in the North America power network. All other power cords supplied are approved for the country of use.

General Safety Summary



Getting Started

The Tektronix CFG280 Function Generator produces low distortion sine waves, square waves, triangle waves, TTL sync signals, positive and negative pulses, and ramp waveforms in a frequency range of 0.1 Hz to 11 MHz. You can also directly control amplitude and DC offset.

The sweep function makes the output signal traverse a range of frequencies. The START and STOP FREQ control settings determine the sweep rate and sweep width internally or the sweep function can be input from an external DC signal.

A voltage-controlled frequency (VCF) input controls the output frequency from an external voltage source. The output frequency can be swept above or below the selected frequency to a maximum of 100:1, depending on the polarity and amplitude of the VCF input and the selected output frequency. Provisions are also made for amplitude modulation of the sine wave output from an external source.

An external gate input allows the generator to operate for the duration of an externally applied gating signal. This mode provides either a single cycle output or a train of preselected waveforms, depending on the gating signal width and the function generator frequency setting.

The CFG280 Function Generator has a frequency counter to count the signal frequency of sine, square and triangle waves from 1 Hz to 100 MHz. The frequency counter features one five-digit display with automatic decimal point placement and LED indicators that show the display measurement unit and mode. It can measure periods in seconds or frequencies in kHz or MHz. The front panel controls also provide selectable gate times (resolution) and selectable X10 attenuation.

The CFG280 has a locking, multiposition handle that folds under the instrument. The instrument comes with a power cord, an installed fuse for 115V operation, and this manual.

Preparing the Function Generator for Use

Check the following items prior to operating the CFG280 Function Generator for the first time (see Figure 1 for locations of items 1 through 3):

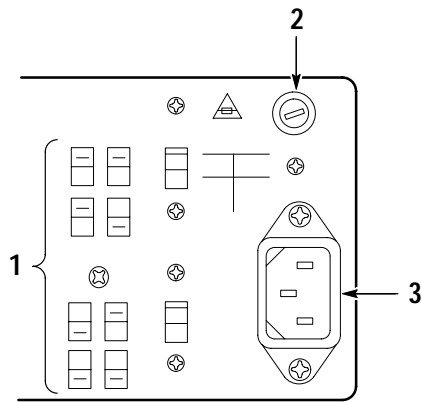

Figure 1: Line Voltage Selectors, Power Input, and Fuse Locations



CAUTION. To prevent damage to the instrument, set the line voltage selectors to the proper voltage setting and install the correct line voltage fuse before operating the equipment.

1. Set the line voltage selectors to the input line voltage. These selectors connect internal wiring for various line voltages. This product is intended to operate from a power source that does not supply more than 250 V_{RMS} between the supply conductors or between either supply conductor and ground. For line voltage ranges, refer to *Appendix A: Specifications* on page 17.



WARNING. To prevent electrical shock, unplug the power cord and disconnect the signal cable from any signal source before checking or replacing the fuse.

2. Check that the correct line fuse is installed. The line fuse provides protection if the equipment malfunctions or an overload occurs. Refer to *Appendix C: Replaceable Parts* on page 29 for fuse part numbers.



WARNING. To prevent electrical shock, connect the power cord to a properly grounded power source. The outside (ground) of this connector is connected through the equipment to the power source ground. Do not remove the ground lug from the power cord for any reason.

3. Connect the input power cord. Use only the power cords specified for this equipment. Refer to *Appendix C: Replaceable Parts* on page 29 for power cord part numbers.

Front Panel

Figure 2 shows the front-panel controls, connectors, and indicators of the CFG280 Function Generator.

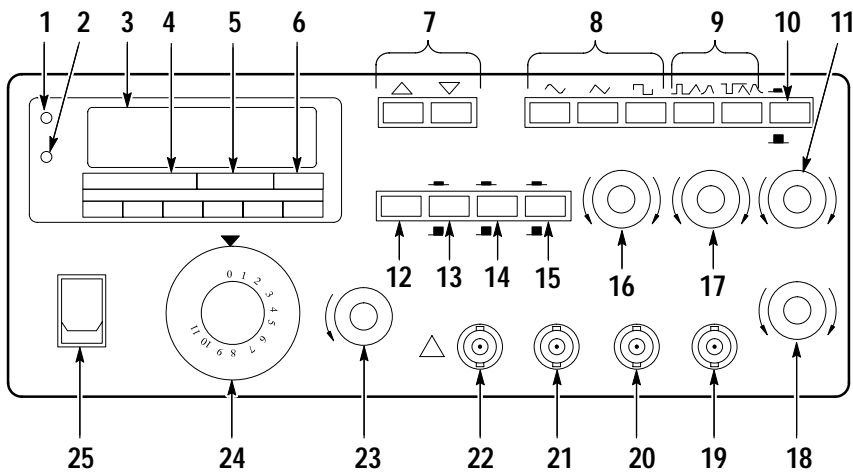

Figure 2: Front Panel Controls, Connectors, and Indicators

1. **OVERRANGE LED.** Lights if you apply a frequency above specified limits to the EXT COUNTER INPUT connector. It also lights if the gate time is too slow for the incoming signal.
2. **GATE LED.** Lights when the frequency counter is making a measurement. The LED will blink when the counter updates the display.
3. **Counter Readout.** This is a five-digit display that shows frequency counter measurements. The decimal point is automatically placed in the appropriate position, depending on the measurement and resolution.
4. **MULTIPLIER LEDs.** Indicate the frequency multiplication factor of the function generator outputs. The 10-1M LED indicates a factor from 10 through 10^6 . You should use the 10-1M LED with the counter readout and FREQUENCY Range LEDs.







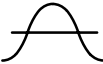

The 1 and 0.1 LEDs provide accurate indication for the two lowest frequency ranges. For example, if the FREQUENCY dial is set on 2.6 and the 1 LED is lighted, the function generator output frequency is 2.6 Hz.

5. FREQUENCY Range LEDs. Indicate the range (either MHz or kHz) of the reading shown on the counter readout. These LEDs also indicate the frequency range of the function generator output. For example, if the FREQUENCY dial is set on 9, the 10-1M LED is lighted, the kHz LED is lighted, and the counter readout shows .090, then the function generator output frequency is 0.090 kHz = 90 Hz.

NOTE. You must have the SOURCE button set on INT (pushed out) to differentiate between the 10 , 10^2 , 10^3 (kHz), 10^4 , 10^5 , and 10^6 (MHz) generator output ranges.

6. SEC LED. Lights when the frequency counter is in PERIOD mode. The counter readout does not show frequency in hertz, but period in seconds. For example, if the FREQUENCY dial is set at 4, the 1 multiplier LED is lighted, and the SEC LED is lighted, the counter readout displays a value close to 0.250. This indicates the generator output period is .25 s (the frequency is 4 Hz).
7. MULTIPLIER Buttons. Set the frequency range. The left button raises the range by a power of ten and the right button lowers the range by a power of ten. For example, if the FREQUENCY dial is set to 4.7 and the output is set to kHz, when you press the left multiplier button the output frequency will jump from 4.7×10^3 Hz (4.7 kHz) to 4.7×10^4 Hz (47 kHz).
8. FUNCTION Buttons. Select the type of waveform generated: sine, triangle, or square.
9. Symmetry Buttons. Select either positive pulse/ramp or negative pulse/ramp (see Table 1 on page 6). When you push either button in, the output frequency is 1/10 of the value shown on the FREQUENCY dial. When you push both buttons in, the output frequency is 1/19 of the value shown on the FREQUENCY dial.

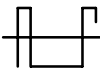
Table 1: Effect of Symmetry Buttons on Output

Waveform	Left Symmetry Button	Right Symmetry Button
		
		
		

10. SWEEP Button. Activates the internal sweep generator, which produces a signal that traverses a range of frequencies. This button enables the SWEEP RATE and SWEEP WIDTH knobs.

You can also feed an external sweep signal into the CFG280 Function Generator through a connector on the rear panel. See *External Sweep* on page 11 for further details.

11. SWEEP RATE Knob. Adjusts how often the frequency sweep reiterates—the rate at which the signal traverses the frequencies. If you pull this button out, the sweep will stop and you can adjust the sweep stop frequency with the SWEEP WIDTH knob.

12. GATE SEL Button. Selects the gate time. If the gate time is too slow for the incoming signal, the OVERRANGE LED lights.

13. ATTN Button. Selects between two levels of input signals for the EXT COUNTER INPUT. When you push the button in, the CFG280 Function Generator attenuates the incoming signal by a factor of ten (the peak-to-peak input level must be between 3 V and 42V). When you push the button out, the function generator does not attenuate the input signal (the peak-to-peak input level must be between 50 mV and 5 V).

- 14. SOURCE Button.** Selects between internal and external counter input. When you push the button in, the counter readout displays the signal frequency count from the EXT COUNTER INPUT. When you push the button out the counter readout displays the frequency count of the signal being generated by the CFG280 Function Generator.
- 15. MAIN Button.** Selects between two voltage ranges: 0 V_{p-p} to 2 V_{p-p} or 0 V_{p-p} to 20 V_{p-p}. This control is used with the AMPLITUDE control to set the voltage level of the MAIN OUT signal.
- 16. AMPLITUDE Knob.** Adjusts the voltage within the presently selected range. This control is used with the MAIN control to set the voltage level of the MAIN OUT signal.
- 17. DC OFFSET Knob.** Sets the DC level (and therefore the polarity) of the MAIN OUT signal. This knob has no effect until you pull it out.
- 18. SWEEP WIDTH Knob.** Adjusts the range of frequencies that are traversed by each sweep.
- 19. SWEEP OUT BNC.** This connector sends sweep signals that you can adjust with the sweep controls. You can use a sweep signal to synchronize an external device such as an oscilloscope.
- 20. MAIN OUT BNC.** This connector sends sine, triangle, square, and positive and negative pulse/ramp signals.
- 21. SYNC OUT BNC.** This connector sends TTL trigger signals. Amplitude and DC offset adjustments do not affect TTL trigger output.
- 22. EXT COUNTER INPUT BNC.** This connector can accept external signals with frequencies between 1 Hz and 100 MHz.
- 23. FREQ FINE ADJ knob.** Allows small adjustments in output frequency.
- 24. FREQUENCY Dial.** Determines the frequency of the function generator output, within the range set by the MULTIPLIER buttons.
- 25. POWER switch.** Toggles instrument power on and off.

Rear Panel

In addition to the line voltage switches, fuse, and power cord receptacle, the items shown in Figure 3 are located on the rear panel.

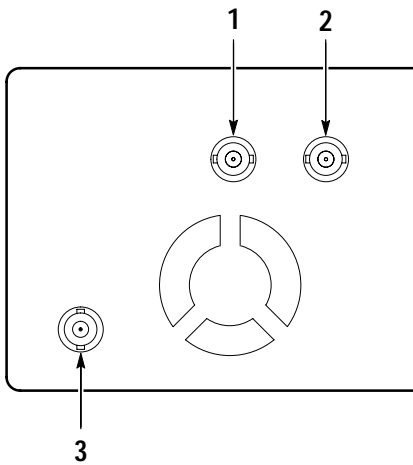

Figure 3: Rear Panel Connections



CAUTION. To avoid the risk of fire or damage to the CFG280 Function Generator, be sure input equipment is properly grounded before connecting it to the function generator.

1. GATE INPUT BNC. This connector accepts external gate signals, which you can use in tone-burst generation. See page 13 for details.
2. EXT AM INPUT BNC. This connector accepts external amplitude modulation signals. See page 12 for details.
3. VCF INPUT BNC. This connector accepts external sweep signals. See page 11 for details.

Reference

This section describes several advanced functions of the CFG280 Function Generator. The variety of swept and modulated signals available from the function generator make it especially useful for such applications as testing servo-system or amplifier response, distortion, and stability. It can be used for FM generation, frequency multiplication, or as a variable, beat-frequency oscillator. It can be used to generate repetition rates or tone bursts. The square wave sync and sweep outputs can be used as a source for TTL logic or to synchronize an external device, such as an oscilloscope. The CFG280 Function Generator is also useful as a source for amplitude modulated signals for various purposes.

TTL Signals

To generate a TTL signal, follow these steps:

1. Connect the **SYNC OUT** connector on the CFG280 Function Generator to the input BNC connector on an oscilloscope (see Figure 4).

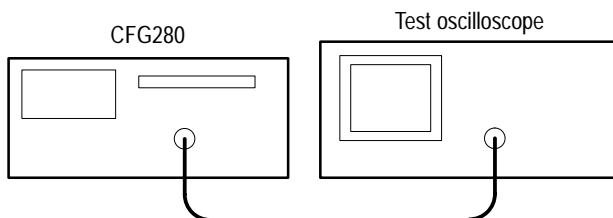

Figure 4: TTL Signal Test Setup

2. Observe the results on the oscilloscope. If necessary, change the volts per division setting or other controls on the oscilloscope to acquire a useful signal.

3. Change the **FREQUENCY** range and rotate the **FREQUENCY** dial. Observe how the frequency of the TTL signal changes.
4. Rotate the **DC OFFSET** knob. Notice that this knob has no effect on TTL signals.

The DC OFFSET knob has no effect because the DC offset of a TTL signal is standardized for compliance with TTL logic. Signals produced from the SYNC OUT connector are not affected by this knob.

5. Rotate the **AMPLITUDE** knob. Notice that this knob has no effect on TTL signals.

The AMPLITUDE knob has no effect because the amplitude of a TTL signal is standardized for compliance with TTL logic.

Internal Sweep

To use the internal sweep function, follow these steps:

1. Connect the **MAIN OUT** BNC on the CFG280 Function Generator to the device under test, such as a filter (see Figure 5).
2. Connect the **SWEEP OUT** connector to one channel of an oscilloscope (see Figure 5).

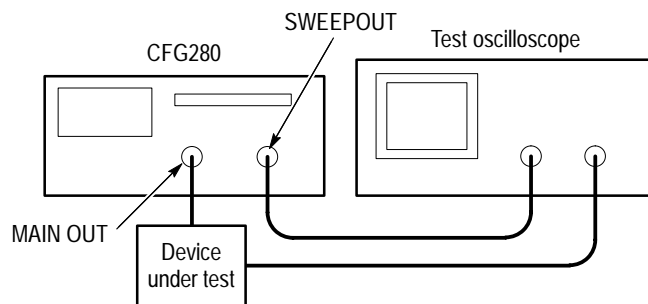

Figure 5: Internal Sweep Test Setup

3. Connect another channel of the oscilloscope to the device under test (see Figure 5).
4. Push the **SWEEP** button out on the function generator to deactivate the internal sweep function.
5. Turn the **FREQUENCY** dial to the desired sweep start frequency (the lowest point on the sweep).
6. Push the **SWEEP** button in to enable the internal sweep function.
7. Pull the **SWEEP RATE** knob out to lock the function generator at the sweep stop frequency (the highest point on the sweep).
8. Adjust the sweep stop frequency with the **SWEEP WIDTH** knob.
9. Now push the **SWEEP** button in to activate the internal linear sweep. Use the **SWEEP RATE** knob to adjust the sweep rate.

External Sweep

To use the external sweep function, follow these steps:

1. Connect the **MAIN OUT** connector on the CFG280 Function Generator to the oscilloscope input connector (see Figure 6).

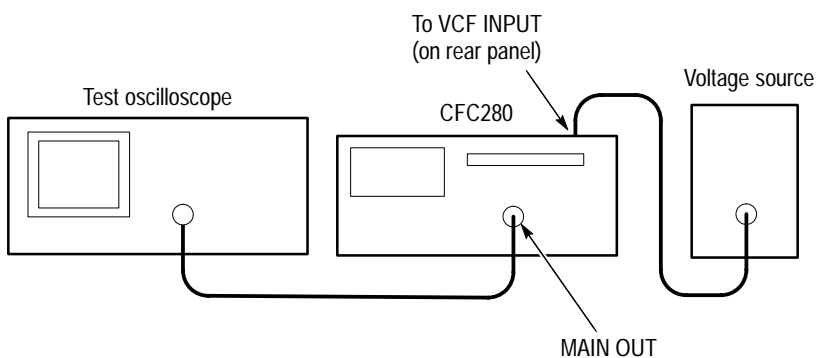

Figure 6: External Sweep Test Setup

2. Turn the **Frequency Dial** to the 0.1 position.



CAUTION. To avoid damage to the CFG280, ensure that the maximum voltage into the rear panel VCF INPUT is no more than ± 10 V pk.

3. Connect an external voltage signal to the **VCF INPUT** on the rear panel of the instrument (see Figure 6).
4. Push the **SWEEP** button out to deactivate the internal sweep function.

When using an external sweep signal, the SWEEP WIDTH and SWEEP RATE knobs have no effect on the signal sweep. Instead, these parameters are controlled entirely by the external signal provided through the rear panel.

Amplitude Modulation

To use the amplitude modulation function, follow these steps.

1. Connect the **MAIN OUT** connector on the CFG280 Function Generator to the oscilloscope input (see Figure 7).

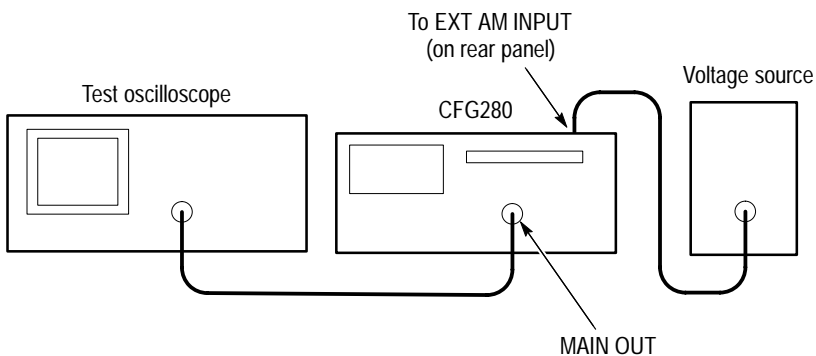

Figure 7: Amplitude Modulation Test Setup

2. Push the sine wave **FUNCTION** button.
3. Set the **FREQUENCY** dial to the desired carrier frequency.



CAUTION. To avoid damage to the CFG280 Function Generator, ensure that the maximum voltage into the rear panel VCF INPUT is no more than $5 V_{p-p}$.

4. Connect an external voltage signal to the **EXT AM INPUT** on the rear panel of the instrument (see Figure 7).
5. Control the amplitude modulation by varying the voltage level of the external voltage source.

Tone-Burst Generation and Stepped Frequency Multiplication

You can use the CFG280 Function Generator as a tone-burst generator or frequency multiplier for checking tone-controlled devices. This application requires another function generator (such as the Tektronix CFG253) to serve as a gating signal source and a ramp generator to serve as a VCF signal source.

1. Connect the **MAIN OUT** connector on the CFG280 Function Generator to the oscilloscope input connector (see Figure 8).
2. Connect the ramp generator output to the **VCF INPUT** connector on the rear of the CFG280 Function Generator (see Figure 8).

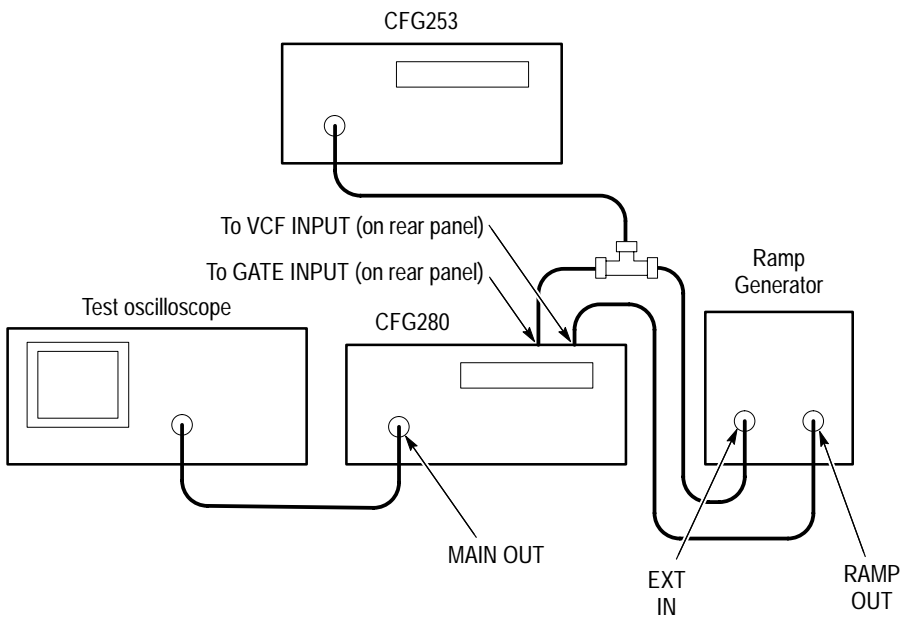

Figure 8: Tone-Burst and Stepped Frequency Multiplication Test Setup

3. Connect the **MAIN OUTPUT** of the CFG253 to a BNC T connector. Connect the BNC T outputs to the **GATE INPUT** connector on the CFG280 Function Generator and the external input on the ramp generator (see Figure 8).
4. Set the ramp generator to generate the desired ramp duration and polarity.
5. Adjust the CFG253 Function Generator output period to the desired number of bursts within the selected ramp duration.
6. Adjust the CFG253 Function Generator output duration to the desired burst width.

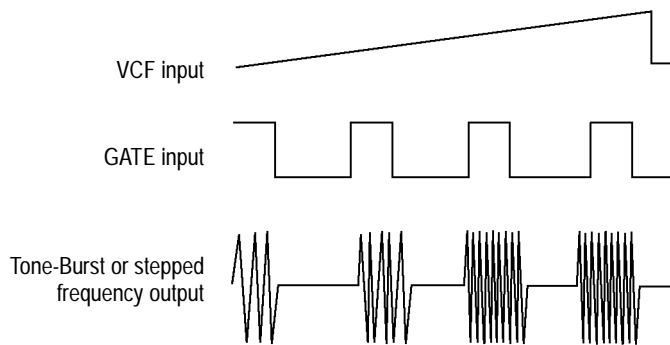

Figure 9: Tone-Burst and Stepped Frequency Typical Waveforms

7. Select the sweep frequency range by adjusting the **FREQUENCY** dial to one end of the swept range (upper or lower limit, depending on the polarity of the ramp) and adjusting the other end with the RG501 output amplitude.

Reference

Appendix A: Specifications

Tables 2 through 5 show characteristics of the CFG280 Function Generator that are guaranteed by warranty.

Table 2: Generator Specifications

Characteristic	Measurement
Outputs	Square wave, sine wave, triangle wave, TTL pulse, positive and negative ramp, pulse and skewed sine wave, AM, and sweep functions
Frequency Ranges	0.1 Hz to 11 MHz, up/down range switchable in eight decade steps
Dial Range	1 to 11 calibrated 0.1 to 1 uncalibrated
Dial Accuracy	±5% of full scale from 0.1 Hz to 10 MHz 11 MHz setting not less than 11 MHz (ambient temperature 20° C to 30° C)
Pulse and Ramp Frequency	1/10 of dial frequency
Pulse and Ramp Aspect Ratio	95:5
Main Output Amplitude	Two ranges: 0–20 V _{p-p} 200 mV to 20 V _{p-p} (open circuit) 100 mV to 10 V _{p-p} (50 Ω load) 0–0.2 V _{p-p} 20 mV to 2 V _{p-p} (open circuit) 10 mV to 1 V _{p-p} (50 Ω load)
Main Output Impedance	50 Ω ±10%
DC Offset	<-10 V to >+10 V (open circuit) <-5 V to >+5 V (into 50 Ω load)

Appendix A: Specifications

Table 2: Generator Specifications (Cont.)

Characteristic	Measurement
Amplitude Flatness (At 10 kHz, 50 Ω Load)	Within ± 0.5 dB, 0.1 Hz to 110 kHz Within ± 1.5 dB, to 1.1 MHz Within ± 2.5 dB, to 11 MHz
Sine Wave Distortion	<1% from 10 Hz to 100 kHz -30 dB at all other frequencies (ambient temperature 20° C to 30° C)
Triangle Wave Linearity	0.1 Hz to 100 Hz $\geq 99\%$ 100 kHz to 1 MHz $\geq 97\%$ Measured from 10% to 90% of waveform
Square Wave Transition Time	≤ 25 ns rise/fall time at maximum output into a 50 Ω load
Square Wave Aberrations	$\leq 4\%$ peak-to-peak at maximum output into a 50 Ω load
Sync TTL Output Rise/Fall Time	<25 ns into 50 Ω load
VCF (FM) Input	A ± 10 V signal input shifts frequency $\geq 1000:1$ up or down with dial set at 0.1 or 11 respectively
External Gate Input	$\geq +2$ V gate signal required, not to exceed +15 V fixed 0 degree start phase
Internal Sweep Rate	Continuously variable from 0.5 to 50 Hz
Internal Sweep Width	Variable from 1:1 to 100:1
Amplitude Modulation	100% with ≤ 5 V _{p-p} , DC to 200 kHz DSB suppressed carrier modulation is also obtained by input modulating the signal with $\geq +2.5$ VDC offset Input impedance = 3 k Ω

Table 3: Counter Specifications

Characteristic	Measurement
Input Selection	Internal and external input selectable
Frequency Range	DC to 100 MHz for internal 1 Hz to 100 MHz, AC coupled for external
Resolution	Frequency mode: 1 Hz, 10 Hz, 1 kHz Period mode: 1 ms
Accuracy	Frequency mode: $\pm(1 \text{ count} + \text{time base error})$ Period mode: $\pm(1 \text{ count} + \text{time base error} + \text{trigger error})$
External Input	
Sensitivity	
30 mV _{RMS}	1 Hz to 50 MHz
50 mV _{RMS}	50 MHz to 100 MHz
Impedance	1 M Ω paralleled by 40 pF
Attenuation	3 V to 42 V (X10) 50 mV to 5 V (X1)
Maximum Input Voltage	42 V peak
Internal Time Base	
Crystal Frequency	10 MHz
Temperature Stability	<0.001% (10 ppm from 0° C to 40° C)
Line Voltage Stability	< ± 1 ppm with 10% line voltage variation
Aging Rate	< ± 10 ppm/yr

Appendix A: Specifications

Table 4: General Specifications

Characteristic	Measurement
Line Voltage Range	Selectable ranges at 50 Hz to 60 Hz 90 VAC to 110 VAC 108 VAC to 132 VAC 198 VAC to 242 VAC 216 VAC to 250 VAC
Operating Temperature	+0° C to +40° C, 80% relative humidity
Nonoperating Temperature	-10° C to +70° C, 70% relative humidity

Table 5: Certifications and Compliances

EC Declaration of Conformity – EMC	Meets intent of Directive 89/336/EEC for Electromagnetic Compatibility. Compliance was demonstrated to the following specifications as listed in the Official Journal of the European Communities: EN 55011 Class A Radiated and Conducted Emissions EN 50081-1 Emissions: EN 60555-2 AC Power Line Harmonic Emissions EN 50082-1 Immunity: IEC 801-2 Electrostatic Discharge Immunity IEC 801-3 RF Electromagnetic Field Immunity IEC 801-4 Electrical Fast Transient/Burst Immunity IEC 801-5 Power Line Surge Immunity
EC Declaration of Conformity – Low Voltage	Compliance was demonstrated to the following specification as listed in the Official Journal of the European Communities: Low Voltage Directive 73/23/EEC, amended by 93/68/EEC. HD401 S1 Safety Requirements for Electronic Measuring Aparatus.

Table 6: Typical Mechanical Specifications

Characteristic	Measurement
Dimensions (H x W x D)	100 mm X 240 mm X 230 mm (3.9 in x 9.5 in x 9.0 in)
Weight	3.0 kg (6.6 lb)

Appendix A: Specifications



Appendix B: Maintenance

This appendix provides information for the basic maintenance of the CFG280 Function Generator.

Cleaning

To clean the CFG280 Function Generator, use a soft cloth dampened in a solution of mild detergent and water. Do not spray cleaner directly onto the instrument, since it may leak into the cabinet and cause damage.

Do not use chemicals containing benzine, benzene, toluene, xylene, acetone, or similar solvents.

Do not use abrasive cleaners on any portion of the function generator.

Preparing for Shipment

If the original packaging is unfit for use or not available, use the following packaging guidelines:

1. Use a corrugated cardboard shipping carton having inside dimensions at least three inches greater than the instrument dimensions.
2. Put the instrument into a plastic bag or wrap to protect it from dampness and loose packing material.
3. Place the instrument into the box and firmly stabilize it with packing material.
4. Seal the carton with shipping tape.

Troubleshooting

Use the following diagrams to identify basic problems with your instrument setup. The diagrams do not provide instructions for or recommend instrument disassembly. If these diagrams fail to solve your problem, send your instrument to the nearest Tektronix service center.

NOTE. These diagrams assume that any other test equipment you use is operating properly. Before you assume a problem exists with the CFG280 Function Generator, check all other test equipment.

Digital Display Blank

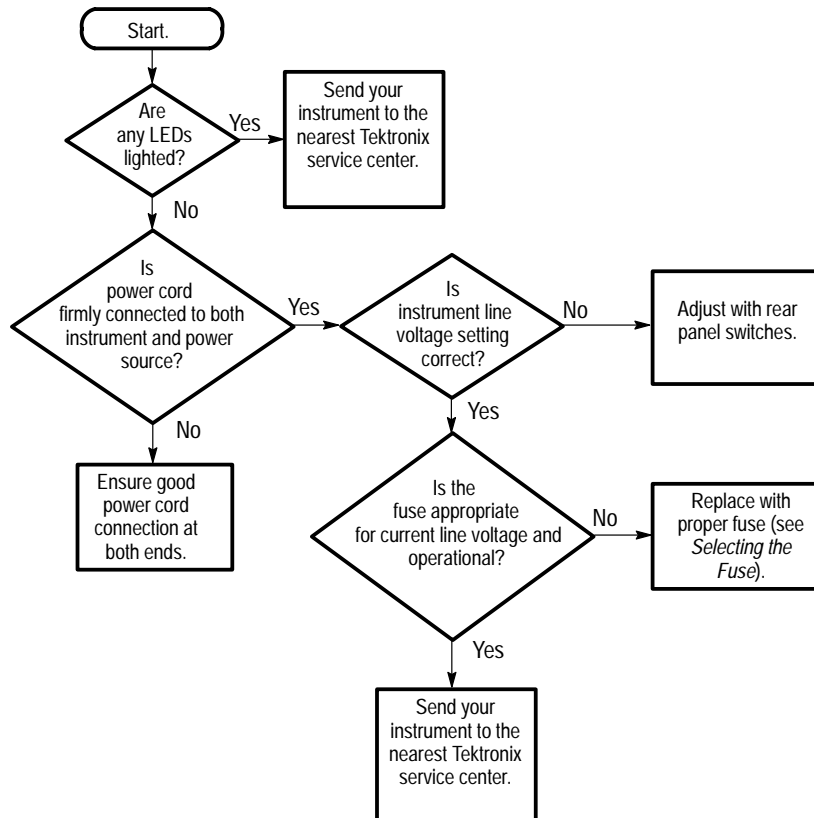

Inappropriate Counter Reading

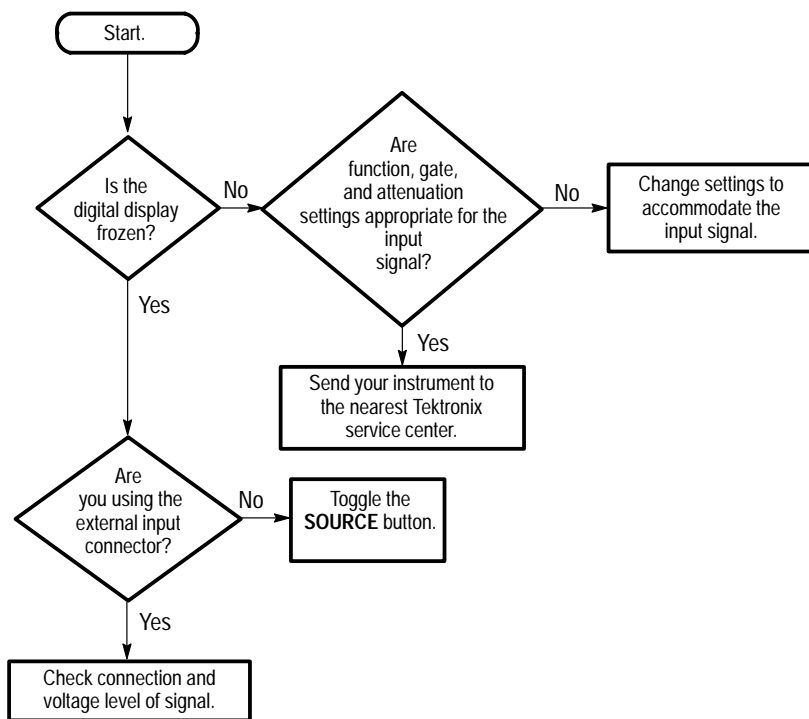

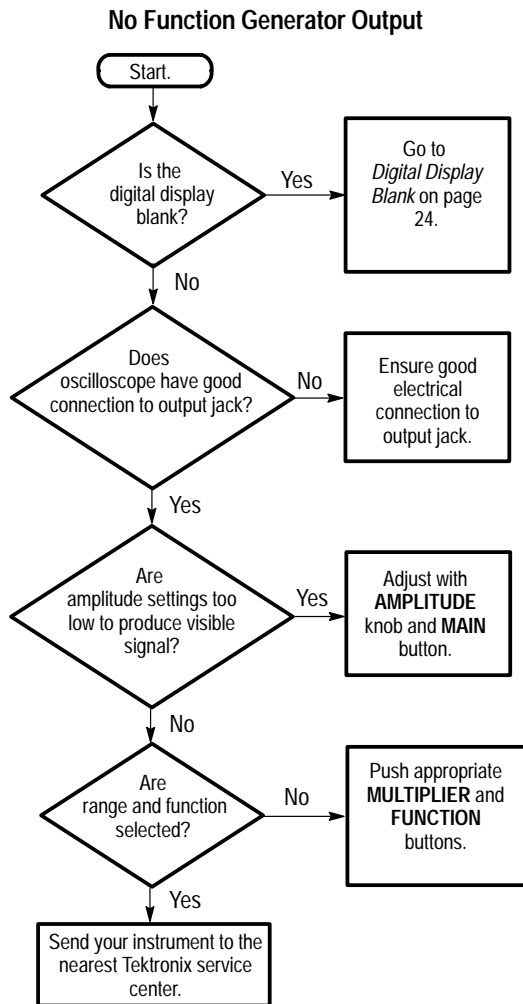

Inappropriate Function Generator Output

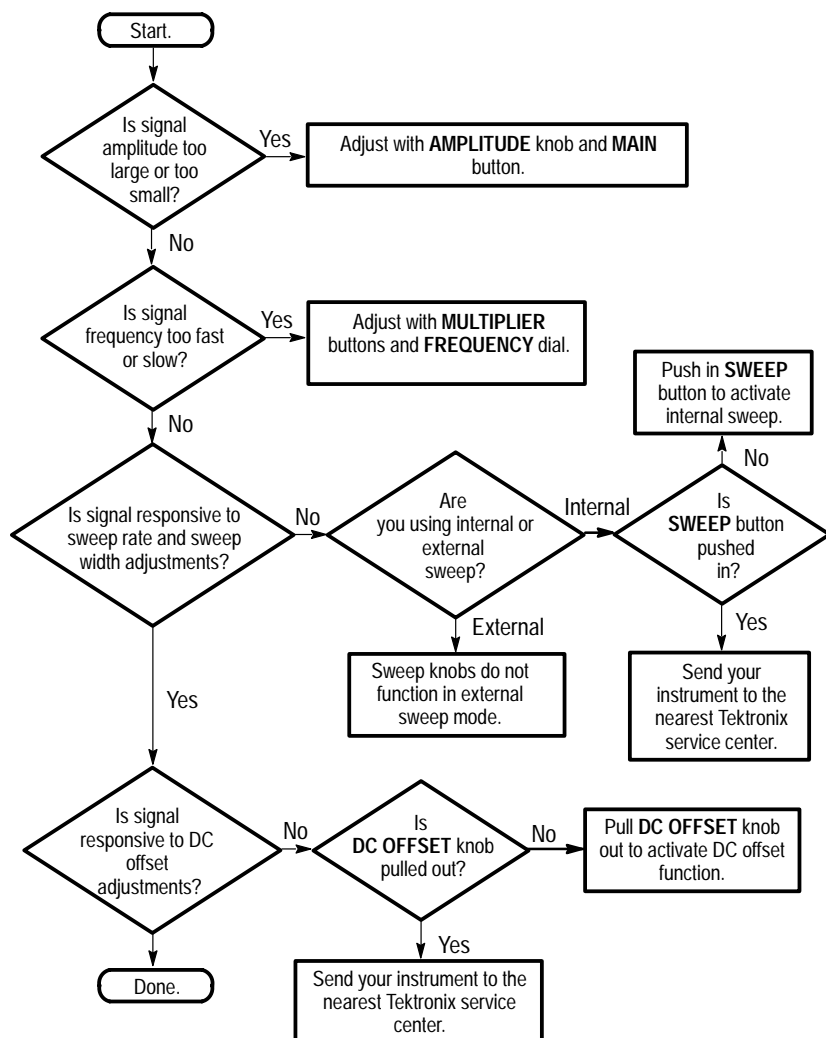

Appendix B: Maintenance

Appendix C: Replaceable Parts

Replaceable parts may be ordered directly from your authorized Tektronix dealer.

Standard Accessories

The following items are shipped with the CFG280 Function Generator:

Table 7: Standard Accessories

Accessory	Tektronix Part Number
Fuse, 3AG, 0.6 A, 250 V, SB (90 – 132 V operation)	159-0043-00
CFG280 User Manual	070-8559-XX
115 V Power Cord	Refer to Table 9

Optional Accessories

The following items are available as optional accessories:

Table 8: Optional Accessories

Accessory	Tektronix Part Number
Fuse, 3AG, 0.3 A, 250 V, SB (198 – 250 V operation)	159-0029-00
230 V Power Cords	Refer to Table 9
36-inch, 50 Ω BNC cable	012-1341-XX
66-inch, 50 Ω coaxial cable signal adapter	103-0275-XX

Appendix C: Replaceable Parts

The following power cords are available.

Table 9: Accessory Power Cords

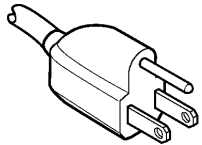
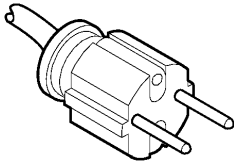
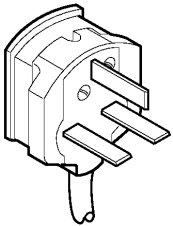
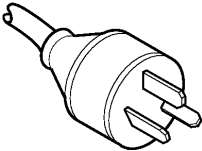
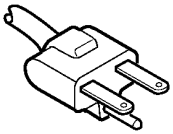
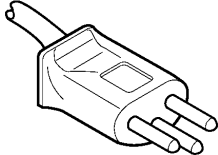
Plug Configuration	Normal Usage	Tektronix Part Number
	North America 115 V	161-0104-00
	Europe 230 V	161-0104-06
	United Kingdom 230 V	161-0104-07
	Australia 230 V	161-0104-05
	North America 230 V	161-0104-08
	Switzerland 230 V	161-0167-00